

TONNE

60

Tadano Faun ATF 60-3

All terrain crane

Dimensions

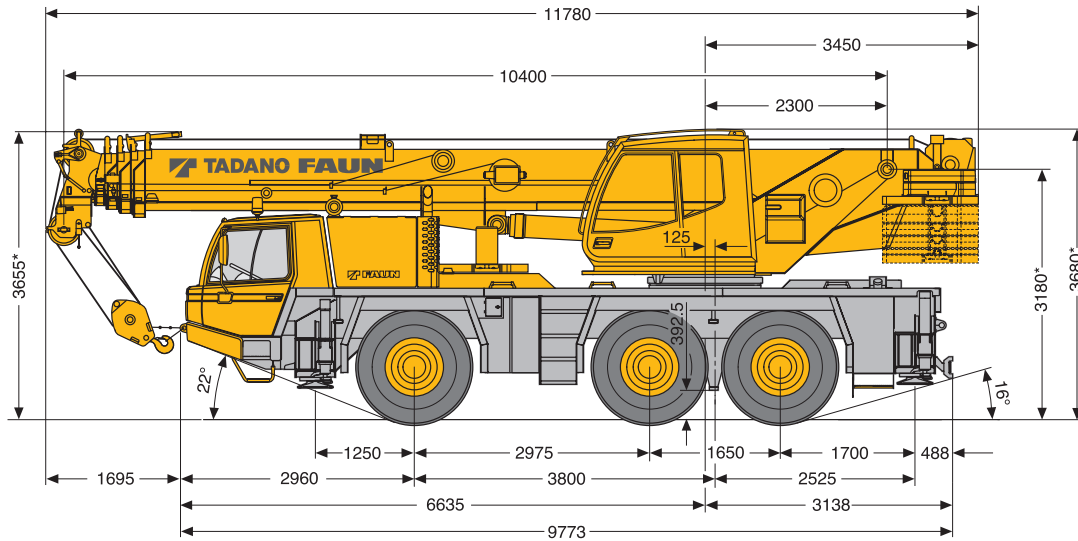

* ± 102

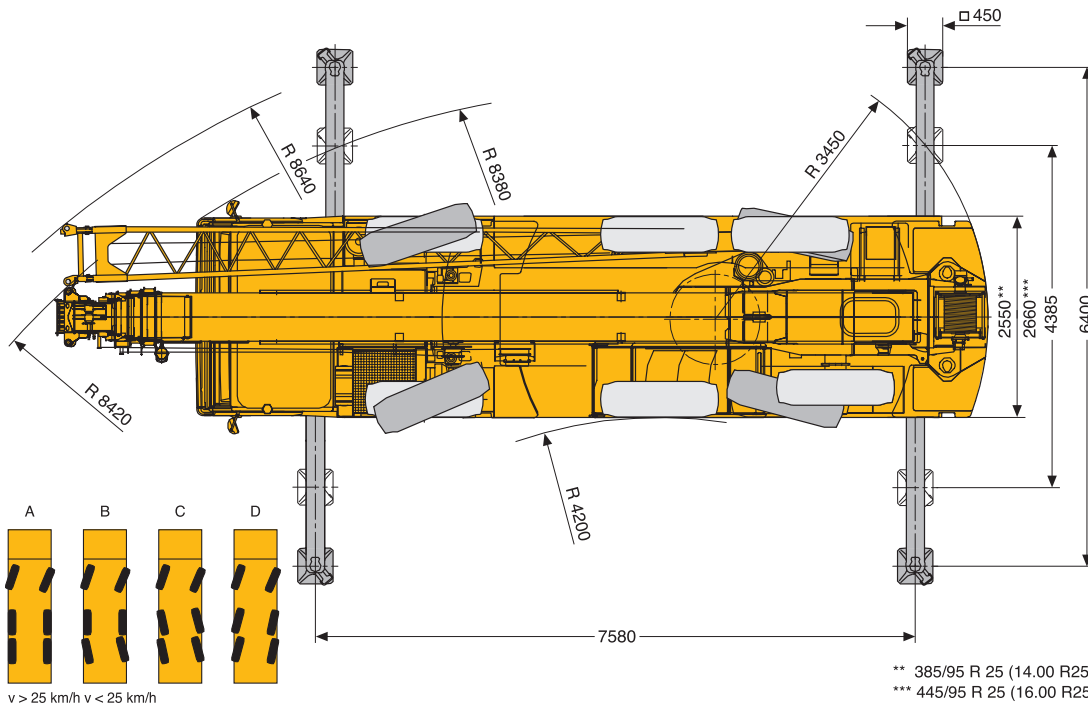

v > 25 km/h v < 25 km/h

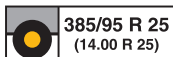

** 385/95 R 25 (14.00 R25)
*** 445/95 R 25 (16.00 R25)

Tadano Faun ATF 60-3

Tadano Faun ATF 60-3

Weights/Working speeds

Weights

	Axle	1	2	3	Total weight t
	(t)	12	12	12	48*



* Incl. 5.0 t counterweight tyres 16.00 R 2, 9m / 16m folding swingaway, 32 t hook block, 6 t swivel hook, drive 6 x 6.

	Lifting capacity	Number of sheaves	Part of line	Weight
	50 t*	5	11	500 kg
	50 t	5	11	500 kg
	32 t	3	7	300 kg
	32 t*	3	7	300 kg
	12.5 t	1	3	170 kg
	6 t	-	1	150 kg





* Rams horn.

Working speeds

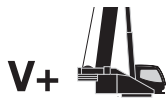

		1	2	3	4	5	6	7	8	9	10	11	12	R1	R2	
14.00	km/h	5	7	9	11	14	18	24	31	40	52	66	80	6	7	66%
16.00	km/h	6	7	10	12	16	20	26	34	44	56	71	80	6	8	59%

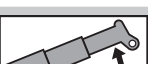

Drive	Infinitely variable	Rope diameter/ length	Maximum single line pull
	0-130 m/min 4th layer Single line	17 mm/200m	57 kN
	0-130 m/min 4th layer Single line	17 mm/200m	57 kN
	0-2.5 min ⁻¹		
	Approx. 33 seconds to reach 82° boom angle		
	Approx. 90 seconds for boom extension from 10.4m-40.2m		

Subject to change without prior notice.

Tadano Faun ATF 60-3

Tadano Faun ATF 60-3

Lifting capacities

DIN / ISO

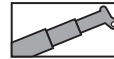

13.2t

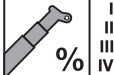
 m	10.4m	14.1m	17.8m	21.6m	25.3m	29.0m	32.7m	36.5m	40.2m
2.5	60.0*								
2.5	55.0								
3.0	49.6	30.0							
3.5	45.2	30.0	30.0						
4.0	41.6	30.0	29.0	20.0					
4.5	38.4	30.0	27.6	20.0					
5.0	35.5	30.0	26.2	20.0	17.0				
6.0	30.5	29.2	22.6	18.7	17.0	13.0	13.0		
7.0	26.3	25.5	20.0	17.5	15.8	13.0	13.0		
8.0	17.8	21.0	20.0	16.2	14.5	12.4	13.0	9.0	7.0
9.0		17.1	17.5	14.4	13.3	11.9	12.0	8.8	7.0
10.0		14.3	14.7	12.9	13.0	11.3	11.0	8.5	7.0
11.0		12.1	13.0	11.9	12.6	10.7	10.1	8.3	7.0
12.0			12.0	11.5	11.6	9.7	9.2	8.1	7.0
14.0			9.4	9.5	9.0	8.1	7.8	7.6	6.5
16.0				7.6	7.7	7.0	6.7	6.5	6.1
18.0				6.2	6.4	6.2	5.4	5.8	5.3
20.0					5.4	5.4	4.5	5.0	4.6
22.0					4.5	4.6	4.0	4.1	3.9
24.0						3.9	3.6	3.4	3.2
26.0						3.3	3.2	2.9	2.7
28.0							2.9	2.4	2.2
30.0							2.5	2.0	1.8
32.0								1.6	1.5
34.0								1.3	1.2
36.0									0.9
 %	0	50	50/100/0	100/0	50/100/0	100/0	100/0	100/50	100
	0	0	50/0/33	50/50	50/100/66	100/83	100/100	100/100	100
	0	0	0/0/33	0/50	50/0/66	25/83	50/100	75/100	100
	0	0	0/0/33	0/50	50/0/66	25/83	50/100	75/100	100

* Subject to change without prior notice.

DIN / ISO

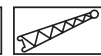
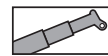

13.2t

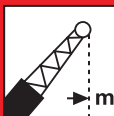
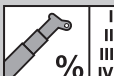
 m	36.5m + 9.0m			40.2m + 9.0m			40.2m + 16.0m		
	5°	20°	40°	5°	20°	40°	5°	20°	40°
10	4.8			3.8					
11	4.8			3.8					
12	4.8	3.8		3.8	3.4		2.2		
14	4.6	3.6	2.5	3.8	3.4	2.5	2.2		
16	4.3	3.3	2.4	3.7	3.3	2.5	2.2	1.8	
18	4.1	3.1	2.3	3.6	3.1	2.4	2.1	1.7	1.3
20	3.8	2.9	2.2	3.4	3.0	2.3	2.1	1.7	1.3
22	3.6	2.8	2.1	3.3	2.9	2.2	2.0	1.6	1.2
24	3.2	2.6	2.1	3.0	2.7	2.1	1.9	1.5	1.2
26	2.6	2.5	2.0	2.7	2.6	2.1	1.8	1.5	1.2
28	2.1	2.3	2.0	2.2	2.4	2.0	1.7	1.4	1.1
30	1.7	1.8	1.9	1.8	1.9	2.0	1.6	1.3	1.1
32	1.3	1.4	1.5	1.4	1.5	1.6	1.5	1.2	1.1
34	1.0	1.1	1.1	1.1	1.2	1.3	1.4	1.2	1.0
36	0.7	0.8	0.8	0.8	0.9	1.0	1.3	1.1	1.0
38	0.5	0.5	0.5	0.6	0.6	0.7	1.0	1.1	1.0
40							0.8	0.9	0.9
42							0.6	0.7	0.8
44								0.5	0.6
 %	100			100			100		
	100			100			100		
	75			100			100		
	75			100			100		

Subject to change without prior notice.

Tadano Faun ATF 60-3

TONNE

60

Tadano Faun ATF 60-3

Lifting heights

DIN / ISO

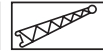
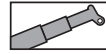

13.2t

Tadano Faun ATF 60-3

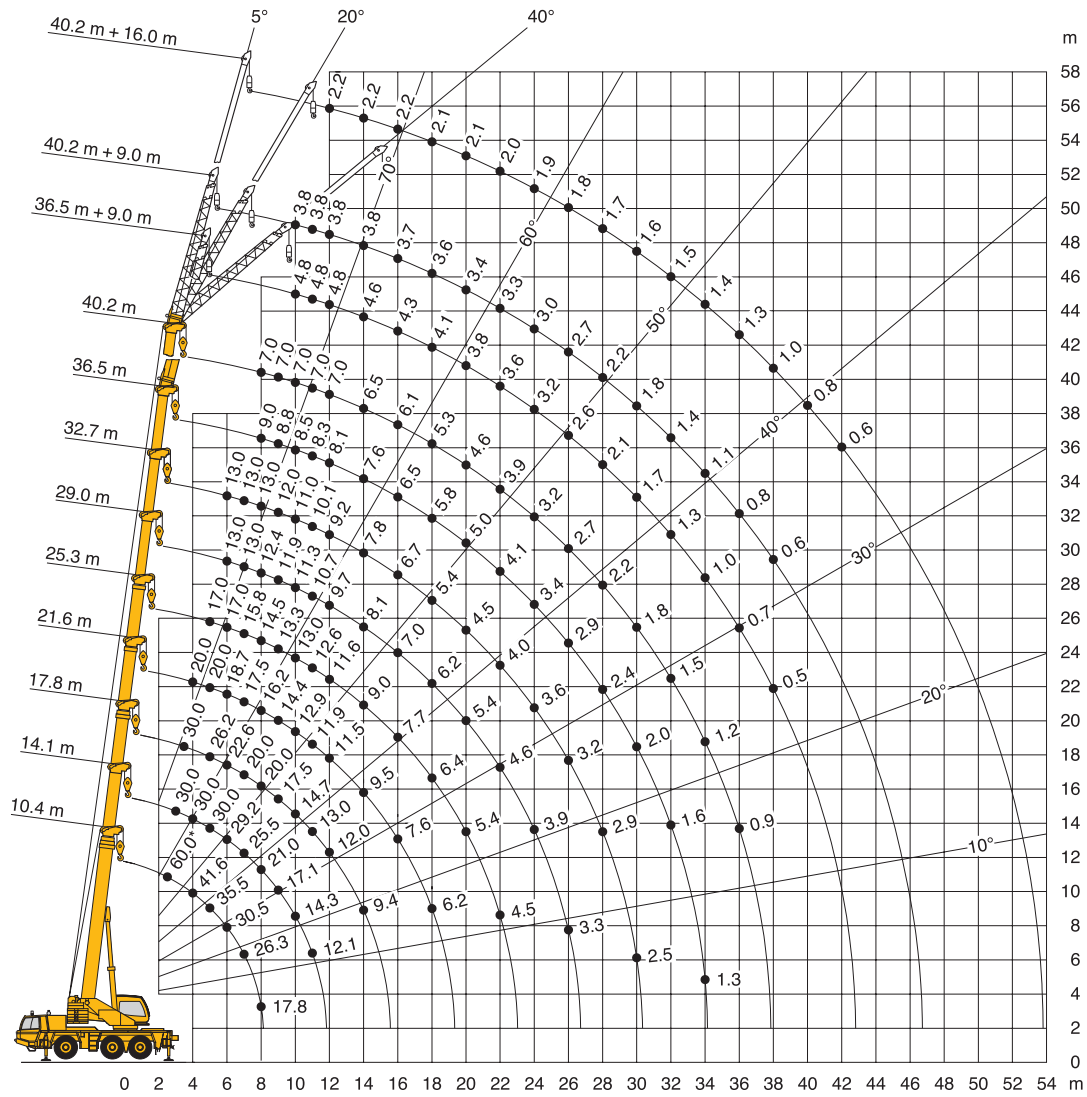

* Over rear, with additional equipment