

Liebherr LTC 1045-3.1

City crane

TONNE

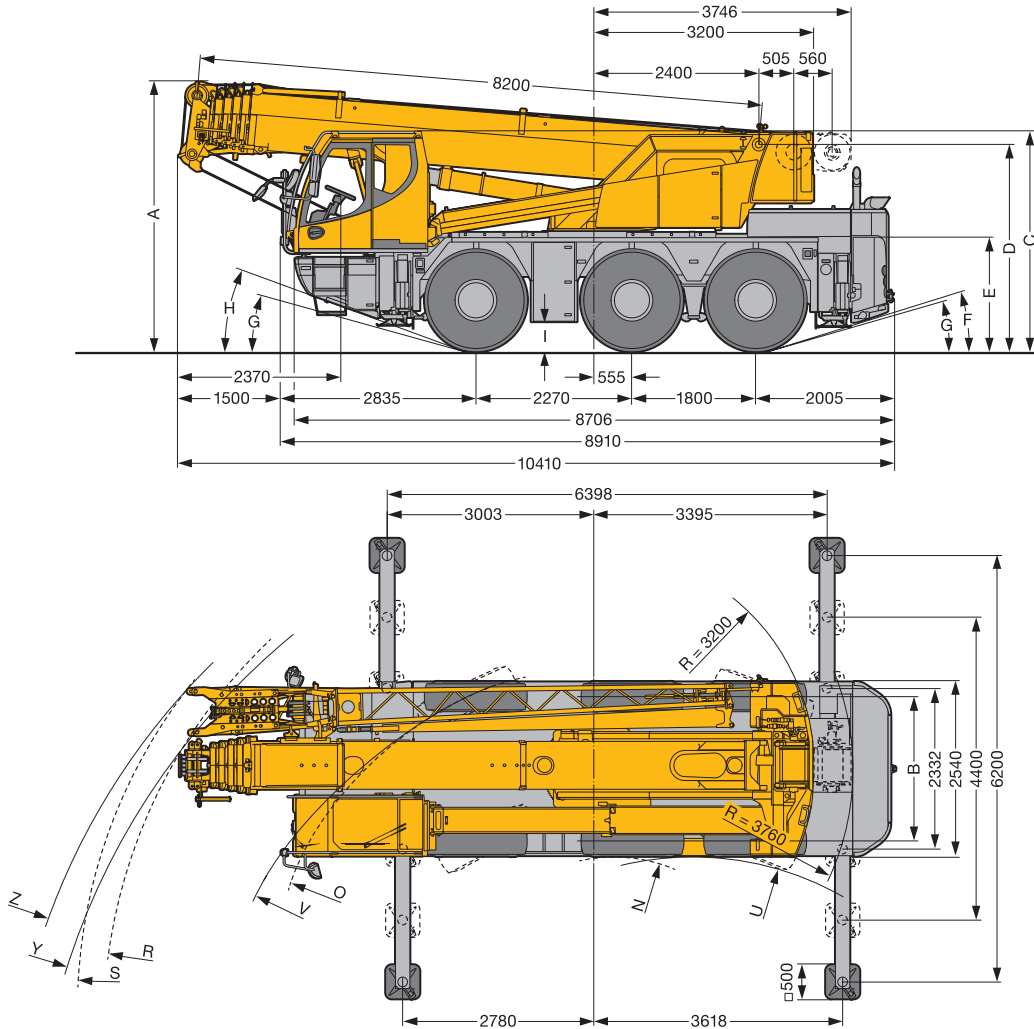

45

Dimensions



	A	A 100mm*	B	C	D	E	F	G	H	I
385/95 R 25 (14.00 R 25)	3830	3730	2113	3110	2918	1570	13°	11°	16°	341
445/95 R 25 (16.00 R 25)	3880	3780	2101	3160	2968	1620	15°	13°	18°	391

* Lowered

								
	U	V	Y	Z	N	O	R	S
385/95 R 25 (14.00 R 25)	4350	7430	9500	10025	2460	5250	7530	7990
445/95 R 25 (16.00 R 25)	5220	8210	10130	10640	2760	5470	7580	8060

Liebherr LTC 1045-3.1

TONNE

45

Liebherr LTC 1045-3.1

Weights/Working speeds

Weights



	Axle	1	2	3	Total weight t
	(t)	12	12	12	36*

* with 6.5t counterweight and folding jib



	Load t	Number of Sheaves	Number of lines	Weight
	45	5	10	400 kg
	32.3	3	7	280 kg
	14.2	1	3	195 kg
	4.8	-	1	75 kg

Working speeds



		1	2	3	4	5	6	R1	R2	
385/95 R 25 (14.00 R 25)	km/h	0-8.4	12.9	20.7	31.9	49.6	80	0-8.9	21.9	39%
445/95 R 25 (16.00 R 25)	km/h	0-9.1	14.1	22.5	34.7	54	80	0-9.6	23.8	36%

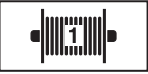

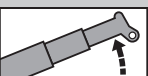
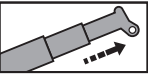
Drive	Infinitely variable	Rope diameter/ length	Maximum single line pull
	0-111 m/min Single line	15 mm/185m	48 kN
	0-111 m/min Single line	15 mm/185m	48 kN
	0-1.9 min ⁻¹		
	Approx. 65 seconds to reach 83° boom angle		
	Approx. 280 seconds for boom extension from 8.2m-26m		

Liebherr LTC 1045-3.1

Liebherr LTC 1045-3.1

Lifting capacities



 m	8.2m	11m	13.8m	16.5m	19.3m	22.1m	24.9m	27.7m	30.4m	33.2m	36m
3.0	42.8	40.6	36.9	30.6	29.6	25.1	19.9				
3.5	38.7	38.5	34.6	30.9	29.2	24.9	19.3				
4.0	35.1	34.8	32.6	31.2	28.6	24.5	18.6	15.4			
4.5	31.7	32.0	31.7	31.3	28.4	23.9	17.9	15.1	12.4		
5.0	28.7	29.0	28.8	28.7	27.6	23.3	17.0	14.9	12.2	10.0	
6.0		23.6	23.6	23.6	23.4	21.9	15.3	14.0	11.7	9.7	7.8
7.0		19.7	19.9	19.9	19.0	18.5	13.8	12.8	11.1	9.3	7.7
8.0		16.0	16.2	16.2	16.3	15.4	13.0	11.7	10.5	8.9	7.5
9.0			13.6	13.7	13.6	13.1	12.2	10.7	9.8	8.4	7.2
10.0			11.4	11.5	11.4	11.2	11.3	9.8	9.1	8.0	7.0
11.0			9.8	9.9	9.7	10.0	9.8	9.0	8.4	7.6	6.7
12.0				8.6	8.6	8.7	8.6	8.3	7.8	7.1	6.4
13.0				7.5	7.8	7.7	7.5	7.4	7.3	6.7	6.1
14.0				6.8	7.0	6.9	6.7	6.8	6.6	6.3	5.8
15.0					6.2	6.1	6.1	6.1	5.9	5.8	5.6
16.0					5.6	5.5	5.6	5.5	5.3	5.2	5.2
17.0						5.0	5.1	5.0	4.9	4.8	4.7
18.0						4.7	4.7	4.5	4.5	4.5	4.3
19.0						4.3	4.3	4.1	4.1	4.1	3.9
20.0							3.9	3.8	3.8	3.7	3.6
21.0							3.6	3.6	3.5	3.4	3.3
22.0							3.4	3.4	3.2	3.2	3
23.0								3.1	3.0	2.9	2.8
24.0								2.9	2.8	2.7	2.5
25.0								2.7	2.8	2.5	2.3
26.0									2.4	2.3	2.1
27.0									2.2	2.1	2.0
28.0									2.0	2.0	1.8
29.0										1.8	1.6
30.0										1.7	1.5
31.0											1.4
32.0											1.3
33.0											1.1

Liebherr LTC 1045-3.1

TONNE

45

Liebherr LTC 1045-3.1

Lifting heights

Liebherr LTC 1045-3.1

