

Liebherr LTM 1060-3.1

All terrain crane

Dimensions

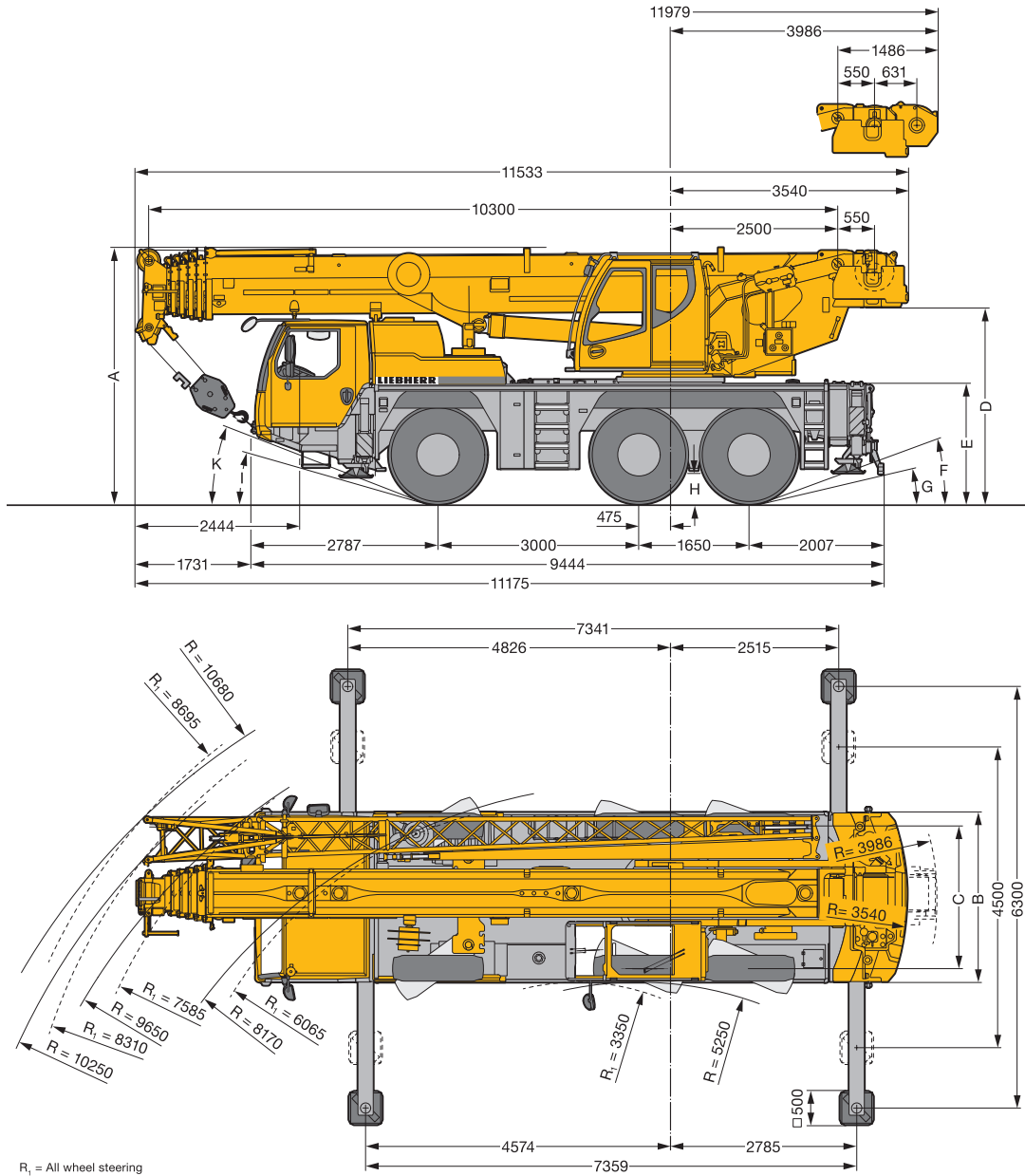

	A	A 100mm*	B	C	D	E	F	G	H	I	K
385/95 R 25 (14.00 R 25)	3750	3650	2550	2160	2863	1710	18°	11°	375	13°	18°
445/95 R 25 (16.00 R 25)	3800	3700	2550	2100	2913	1760	20°	12°	425	15°	20°
525/80 R 25 (20.50 R 25)	3800	3700	2690	2170	2913	1760	20°	12°	425	15°	20°

* Lowered

Liebherr LTM 1060-3.1

Liebherr LTM 1060-3.1

Weights/Working speeds

Weights







	Axle	1	2	3	Total weight t
	(t)	12	12	12	36*

* with 5.5t counterweight



	Load t	Number of sheaves	Number of lines	Weight
	60	7	15	400 kg
	46.1	5	11	400 kg
	30.2	3	7	280 kg
	13.3	1	3	195 kg
	4.5	-	1	95 kg

Working speeds



	Km/h Minimum	Km/h Maximum			
385/95 R 25 (14.00 R 25)	0.59	80	69.8%		12 / R2
445/95 R 25 (16.00 R 25) 525/80 R 25 (20.50 R 25)	0.65	80	61.7%		4 / R2

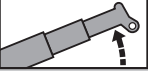
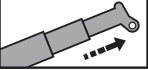

Drive	Infinitely variable		Rope diameter/ length	Maximum single line pull
	0-130 m/min	Single line	15 mm / 220m	45 kN
	0-130 m/min	Single line	15 mm / 220m	45 kN
	0-1.6 min ⁻¹			
	Approx. 60 seconds to reach 82° boom angle			
	Approx. 330 seconds for boom extension from 10.3m-48m			

Liebherr LTM 1060-3.1

Liebherr LTM 1060-3.1

Lifting capacities

DIN / ISO

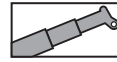

m	10.3m	10.3m	13.8m	17.3m	20.7m	24.2m	27.7m	31.2m	34.6m	38.1m	41.6m	45.1m	48m
	*												
2.1	60.0												
2.4	58.8												
2.5	58.2												
3.0	54.6	42.3	41.5	40.4	34.1	29.6	22.7						
3.5	49.9	42.3	42.2	40.7	34.4	30.0	23.2						
4.0	44.5	40.5	40.2	38.1	34.8	30.2	23.6	18.6					
4.5	39.8	37.2	36.9	34.9	33.3	29.9	24.0	18.9	14.6				
5.0	36.4	34.2	34.3	32.9	31.1	29.6	24.1	19.1	14.8				
6.0	31.6	28.7	29.1	29.3	28.2	26.6	23.7	19.2	15.0	11.7			
7.0	26.5	24.1	24.6	24.8	24.8	23.9	22.9	18.7	15.1	12.0	9.5	7.2	
8.0			20.9	21.1	21.3	20.9	19.7	17.7	14.8	12.1	9.6	7.4	6.1
9.0			17.8	18.3	18.5	18.0	17.0	15.9	14.2	11.9	9.7	7.4	6.2
10.0			15.2	15.8	15.9	15.7	14.9	14.3	13.3	11.5	9.5	7.4	6.3
11.0			13.3	13.7	13.7	13.6	13.1	12.6	12.2	11.0	9.2	7.3	6.3
12.0				11.9	12.0	11.9	11.7	11.6	11.1	10.4	8.8	7.1	6.2
13.0				10.6	10.6	10.5	10.5	10.5	10.2	9.7	8.5	6.9	6.1
14.0				9.4	9.5	9.4	9.7	9.4	9.3	8.7	8.2	6.7	5.9
15.0					8.5	8.9	8.7	8.5	8.4	8.0	7.8	6.5	5.8
16.0					7.7	8.1	7.9	7.7	7.6	7.6	7.2	6.3	5.7
17.0					7.0	7.3	7.2	7.0	7.1	7.0	6.6	6.1	5.5
18.0					6.8	6.7	6.6	6.6	6.5	6.4	6.2	5.9	5.4
19.0						6.2	6.0	6.2	6.0	5.9	5.8	5.5	5.2
20.0						5.7	5.7	5.7	5.5	5.5	5.4	5.0	4.9
21.0						5.3	5.4	5.2	5.2	5.1	5.0	4.6	4.5
22.0							5.0	4.9	4.9	4.7	4.6	4.2	4.2
23.0							4.7	4.5	4.5	4.4	4.2	3.9	3.9
24.0							4.3	4.2	4.2	4.0	3.9	3.6	3.6
25.0							4.1	3.9	3.9	3.7	3.6	3.3	3.3
26.0								3.7	3.7	3.5	3.3	3.1	3.0
27.0								3.5	3.4	3.2	3.1	2.8	2.8
28.0								3.3	3.2	3.0	2.9	2.6	2.6
29.0									3.0	2.8	2.7	2.4	2.4
30.0									2.8	2.6	2.5	2.3	2.2
31.0									2.6	2.4	2.3	2.1	2.1
32.0									2.5	2.3	2.1	1.9	1.9
33.0										2.1	2.0	1.7	1.8
34.0										2.0	1.8	1.6	1.6
35.0										1.8	1.7	1.5	1.5
36.0											1.6	1.3	1.3
37.0											1.4	1.2	1.2
38.0											1.3	1.1	1.1
39.0											1.2	1.0	1.0
40.0												0.9	0.9

* Over rear

Liebherr LTM 1060-3.1

TONNE

60

Liebherr LTM 1060-3.1

Lifting heights

Liebherr LTM 1060-3.1

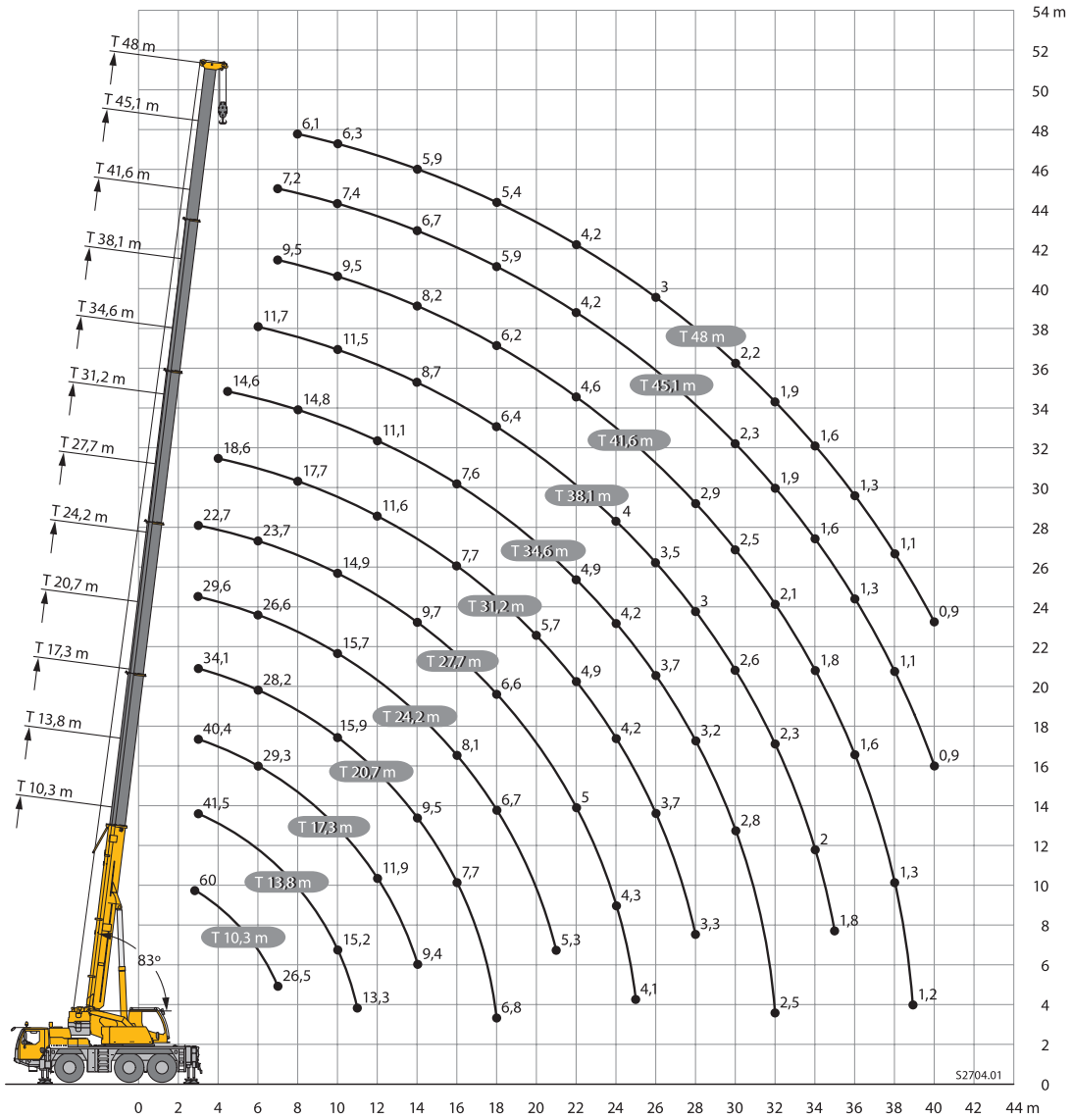

* Over rear, with additional equipment