

Liebherr LTM 1030-2.1

All terrain crane

Dimensions

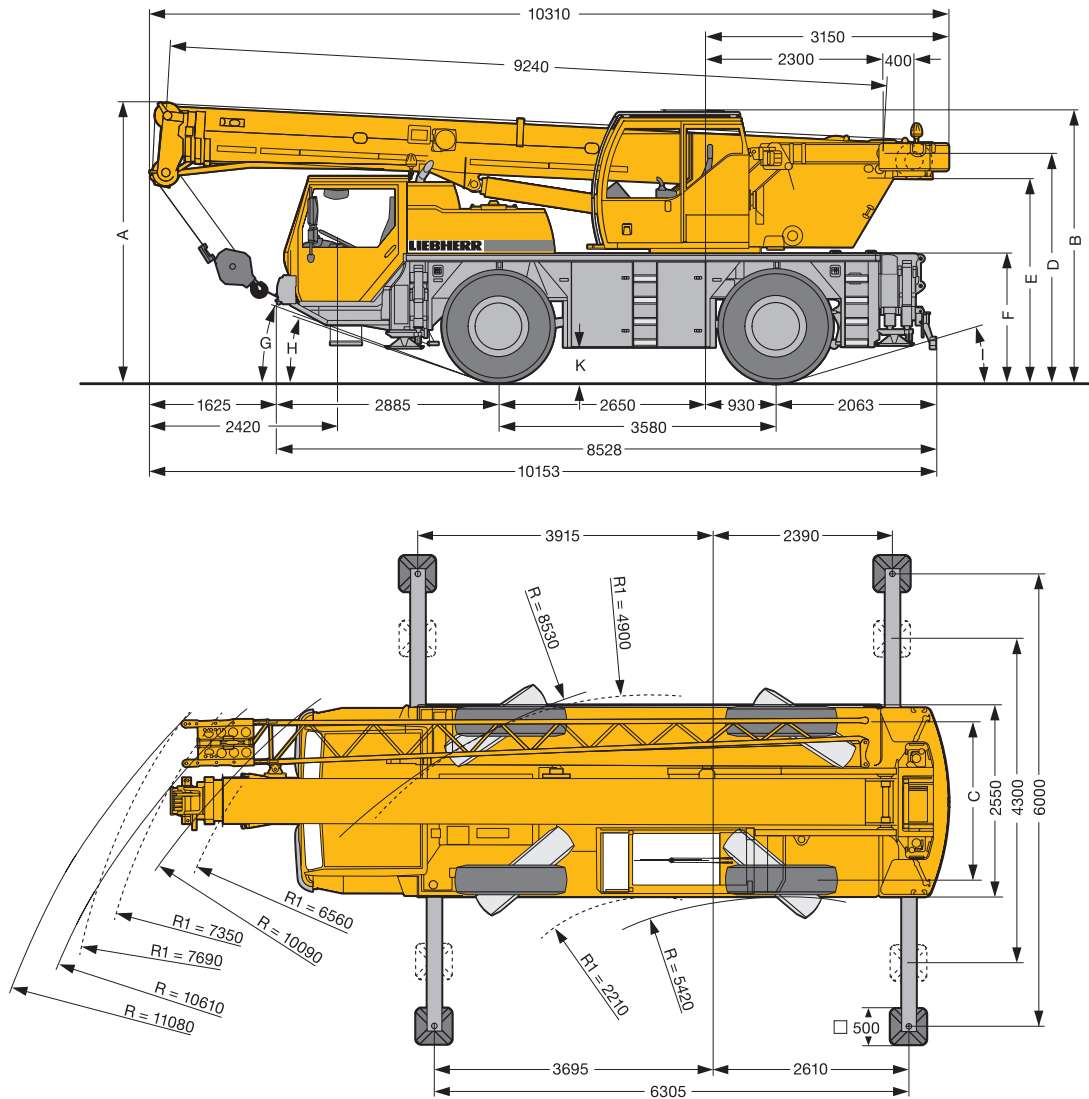

R₁ = All wheel steering

	A	A 100mm*	B	C	D	E	F	G	H	I	K
385/95 R 25 (14.00 R 25)	3550	3450	3445	2113	2884	2554	1598	18°	16°	11°	375
445/95 R 25 (16.00 R 25)	3600	3500	3495	2101	2934	2604	1648	19°	17°	12°	425

* Lowered

Liebherr LTM 1030-2.1

Liebherr LTM 1030-2.1

Weights/Working speeds

Weights



	Axle	1	2	Total weight t
	(t)	12	12	24*

* with 2.3t counterweight and folding jib



	Load t	Number of Sheaves	Number of line	Weight
	35	5	10	265 kg
	22.4	3	7	165 kg
	10.0	1	3	145 kg
	3.3	-	1	75 kg

Working speeds



		1	2	3	4	5	6	R1	R2	
385/95 R 25 (14.00 R 25)	km/h	09.5	14.5	23	36	56	80	9.5	23	>60%
445/95 R 25 (16.00 R 25)	km/h	10.5	16	25.5	39	61	80	10.5	25.5	60%

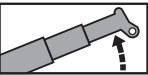
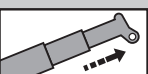

Drive	Ininitely variable	Rope diameter/ length	Maximum single line pull
	0-120 m/min Single line	13 mm/150m	33 kN
	0-2.4 min ⁻¹		
	Approx. 633 seconds to reach 81° boom angle		
	Approx. 60 seconds for boom extension from 9.2m-30m		

Liebherr LTM 1030-2.1

Liebherr LTM 1030-2.1

Lifting capacities



 m	9.2m		14.4m		19.6m		24.8m		29m		30m	
	*			**		**		**		**		**
3.0	35.0	30.3	19.3									
3.5	30.2	27.3	19.8		17.3							
4.0	26.2	24.9	20.3		17.6		13.0					
4.5	23.2	22.8	20.9		17.9		13.0		9.0		8.3	
5.0	20.7	20.7	20.6		17.3	13.2	13.0	11.3	9.0	3.8	8.3	
6.0	16.9	16.9	17.1	16.3	16.0	13.1	13.0	10.9	9.0	3.6	8.3	1.9
7.0			14.2	14.2	13.5	12.9	12.0	10.6	9.0	3.4	8.3	1.8
8.0			11.4	11.4	11.3	11.3	10.7	10.2	8.6	2.7	7.9	1.7
9.0			9.4	9.4	9.5	9.5	9.2	9.2	8.2	2.6	7.6	1.6
10.0			7.9	7.9	8.0	8.0	8.0	8.0	7.6	2.5	7.2	1.5
12.0			5.9	5.9	6.0	6.0	6.0	6.0	6.0	2.4	6.0	1.3
14.0					4.6	4.6	4.7	4.7	4.7	2.2	4.7	1.2
16.0					3.7	3.7	3.8	3.8	3.8	2.1	3.8	1.1
18.0							3.1	3.1	3.1	2.0	3.1	1.0
20.0							2.5	2.5	2.5	1.9	2.5	0.9
22.0							2.1	2.1	2.1	1.7	2.1	0.9
24.0									1.7	1.3	1.7	0.7
26.0									1.4	0.9	1.4	

* Over rear

** Telescopic loads



 m	9.2m		14.4m		19.6m		24.8m		29m		30m	
	*			**		**		**		**		**
3.0	33.4	30.0	19.3									
3.5	28.4	27.0	19.8		17.3							
4.0	24.6	24.5	20.3		17.6		13.0					
4.5	21.8	21.8	20.9		17.9		13		9.0		8.3	
5.0	19.4	19.4	19.1		17.1	13.2	13.0	11.3	9.0	3.8	8.3	2.0
6.0	14.9	14.9	14.6	14.6	13.4	12.8	12.3	10.9	9.0	3.6	8.3	1.9
7.0			11.5	11.5	10.9	10.9	10.2	10.2	9.0	3.4	8.3	1.8
8.0			9.1	9.1	9.0	9.0	8.5	8.5	8.1	2.7	7.9	1.7
9.0			7.5	7.5	7.6	7.6	7.2	7.2	6.9	2.6	6.8	1.6
10.0			6.2	6.2	6.3	6.3	6.2	6.2	5.9	2.5	5.9	1.5
12.0			4.5	4.5	4.6	4.6	4.7	4.7	4.5	2.4	4.5	1.3
14.0					3.5	3.5	3.5	3.5	3.5	2.2	3.5	1.2
16.0					2.7	2.7	2.7	2.7	2.7	2.1	2.7	1.1
18.0							2.1	2.1	2.2	2.0	2.1	1.0
20.0							1.7	1.7	1.7	1.7	1.7	0.9
22.0							1.3	1.3	1.3	1.3	1.3	0.9
24.0									1.0	1.0	1.0	0.7
26.0									0.8	0.8	0.8	

* Over rear

** Telescopic loads

Liebherr LTM 1030-2.1

TONNE

35

Liebherr LTM 1030-2.1

Lifting heights

Liebherr LTM 1030-2.1

